

E045FLL840C | Keplero Quantum 60

Recessed professional projector with a fixed optical unit

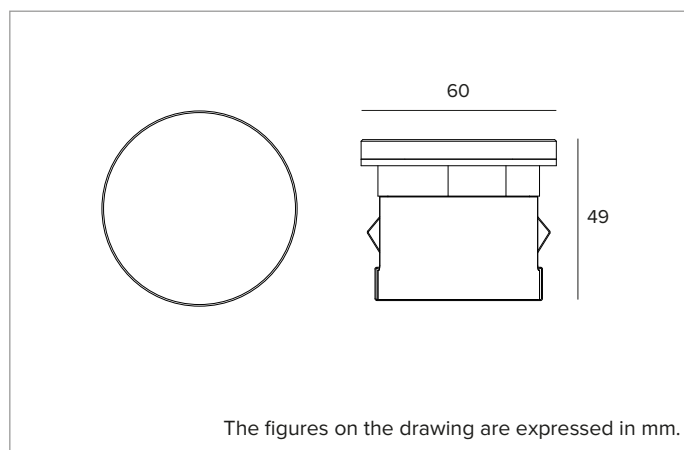

	4000K	H(m)	D(m)	Emax(lx)		
	Ra80		34°			
Fixture Power	5W	1	0.62	856		
Source Flux	614lm	2	1.23	214		
Fixture Flux	417lm	3	1.85	95		
Efficacy	89lm/W	4	2.47	54		
TS2234	Imax=1395cd/klm	Imax	856cd	5	3.09	34



SOURCE

High efficiency Chip on Board LED. 4000K (Ra80) colour temperature.

Energy efficiency class: D

Nominal power: 4,2W

Nominal flux: 614lm

Colour rendering index: 80

Rf: 81

Rg: 97

CCT nominal: 4000K

ILLUMINOTECHNICAL CHARACTERISTICS

Optical grade PMMA lens and holographic diffusing filter.

Optic: LENS

Beam angles: FL

Optical efficiency: 68%

Fixture flux: 417lm

Luminous efficacy: 89lm/W

Photobiological safety: Compliant with RG1 low risk group

MECHANICAL CHARACTERISTICS

Aluminium body made by CNC machining process and treated with black anodizing. All-glass version. Extra clear protective glass.

Colour and finish: All-glass

Version: CLEAR GLASS

Degree of protection: IP66,IP67,IP68

Mechanical Resistance: IK10

ELECTRICAL CHARACTERISTICS

24Vdc power supply. ON-OFF, DALI2 remote driver to be ordered separately. Precabled with 1,5m 2x0,5mm² cable. Casambi control system available via accessory (for products with DALI2 driver only).

Fixture Power: 5W

Power supply: 24Vdc

Insulation Class: CLASS 3

Driver included: NO

Class F: YES

Ambient temperature: -25°C / +35°C

INSTALLATION

In-ground installation by a reinforced nylon sleeve, to be ordered separately. The sleeve is pre-set for flush installation. 20kN resistance to static load.

NOTES

IP68: the fixture is not suitable for permanent underwater installation but can withstand temporary accidental immersion to a depth of 1.5 metres (max.1h). All the Keplero Quantum 60 all-glass versions meet the walk-over requirements set out in the EN 60598-2-13 standard. Low temperatures on the glass make them suitable even for installation in "special areas", such as spaces for children. It features the "Waterblock Smart" technical solution which involves resin-sealing the connection cables to minimize the risk of moisture rising into the fixture. Commissioning of the control system via free APP; the intervention of a specialist technician can be quoted on request.

WARRANTY

5 years.

WARNING

Luminaire designed for disposal/recycling at end-of-life. Replaceable (LED only) light source by a professional. Non-replaceable control gear.

Due to the technological evolution of the electronic components, the data provided may be updated, and as such, confirmation must be requested during the order process.

Luminous flux and power supply have +/-10% tolerances with respect to the indicated value. tq +25°C (CIE 121).

We reserve the right to make technical changes.

Targetti Sankey S.r.l.
Via Pratese, 164
50145 Firenze - Italy
Tel: +39 055 37911
targetti.com
targetti@targetti.com

CCIAA Firenze
Share Capital:
€ 500.000,00
VAT N. (IT):
01537660480
R.E.A: FI-275656

TARGETTI

E045FLL840C | Keplero Quantum 60

Recessed professional projector with a fixed optical unit

Related codes

Sleeve



L mm	H mm	P mm	Colour	Code
190	108	190		A131SS
190	108	190		A131CB
190	108	190		A131EB

Reinforced nylon installation sleeve.

The sleeve is designed for the flush installation of All-glass versions.

Complete with a cover element to protect the recessed housing during concrete pouring.

AxB 190x190 H. 108

Power Supply

Dimensions LxHxP mm	Power	Power supply	Output voltage	IP	Code
171x37x62	60W MAX	220-240Vac	24Vdc	IP67	A134EL
228x39x68	150W MAX	220-240Vac	24Vdc	IP67	A137EL

Electronic ON-OFF power supply.

Dimensions LxHxP mm	Power	Power supply	Output voltage	IP	Code
150x35x53	60W MAX	220-240Vac	24Vdc	IP67	A134D2
191x38x63	120W MAX	220-240Vac	24Vdc	IP67	A136D2

DALI2 power supply.

Accessories

Connector



Code

1E2493

Linear connection box IP68.

4 poles max. wire section 2.5mm².

Cable diameter range from 7 to 12mm.



Code

1E2494

Multiple connection box IP68.

1 IN - 3 OUT 4 poles max. wire section 2.5mm².

Cable diameter range from 6 to 12mm.

Tool



Code

1E3305

Tightening wrench for the connector kit.

Due to the technological evolution of the electronic components, the data provided may be updated, and as such, confirmation must be requested during the order process.

Luminous flux and power supply have +/-10% tolerances with respect to the indicated value. tq +25°C (CIE 121).

We reserve the right to make technical changes.

Targetti Sankey S.r.l.
Via Pratese, 164
50145 Firenze - Italy
Tel: +39 055 37911
targetti.com
targetti@targetti.com

CCIAA Firenze
Share Capital:
€ 500.000,00
VAT N. (IT):
01537660480
R.E.A.: FI-275656

TARGETTI